

## Features

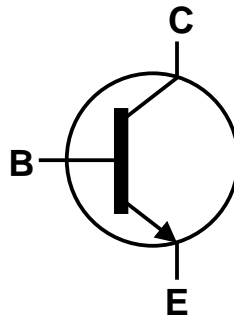
- $BV_{CEO} > 32V$
- Max Continuous Current  $I_C = 1A$
- Epitaxial Planar Die Construction
- Complementary PNP Type Available (2DB1132)
- Ideally Suited for Automated Assembly Processes
- Ideal for Medium Power Switching or Amplification Applications
- **Totally Lead-Free & Fully RoHS compliant (Notes 1 & 2)**
- **Halogen and Antimony Free. "Green" Device (Note 3)**
- **Qualified to AEC-Q101 Standards for High Reliability**

## Mechanical Data

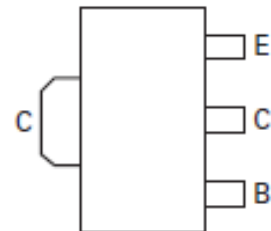
- Case: SOT89
- Case Material: Molded Plastic. "Green" Molding Compound.
- UL Flammability Rating 94V-0
- Moisture Sensitivity: Level 1 per J-STD-020
- Terminals: Matte Tin Finish (Ⓔ3)
- Weight: 0.055 grams (Approximate)



Top View



Device Symbol



Pin Out – Top View

## Ordering Information (Note 4)

Product	Marking	Reel size (inches)	Tape width (mm)	Quantity per reel
2DD1664P-13	N13P	13	12	2,500
2DD1664Q-13	N13Q	13	12	2,500
2DD1664R-13	N13R	13	12	2,500

- Notes:
1. No purposely added lead. Fully EU Directive 2002/95/EC (RoHS) & 2011/65/EU (RoHS 2) compliant.
  2. See <http://www.diodes.com> for more information about Diodes Incorporated's definitions of Halogen and Antimony free, "Green" and Lead-Free.
  3. Halogen and Antimony free "Green" products are defined as those which contain <900ppm bromine, <900ppm chlorine (<1500ppm total Br + Cl) and <1000ppm antimony compounds.
  4. For packaging details, go to our website at <http://www.diodes.com>

## Marking Information



N13x = Product Type Marking Code:  
 Where N13P = 2DD1664P  
 N13Q = 2DD1664Q  
 N13R = 2DD1664R  
 YWW = Date Code Marking  
 Y = Last digit of year ex: 1 = 2011  
 WW = Week code (01 – 53)

### Maximum Ratings (@T<sub>A</sub> = +25°C, unless otherwise specified.)

Characteristic	Symbol	Value	Unit
Collector-Base Voltage	V <sub>CB0</sub>	40	V
Collector-Emitter Voltage	V <sub>CEO</sub>	32	V
Emitter-Base Voltage	V <sub>EBO</sub>	6	V
Continuous Collector Current	I <sub>C</sub>	1	A
Peak Pulse Current (Note 6)	I <sub>CM</sub>	2	A

### Thermal Characteristics

Characteristic	Symbol	Value	Unit
Power Dissipation (Note 5)	P <sub>D</sub>	1	W
Thermal Resistance, Junction to Ambient (Note 5)	R <sub>θJA</sub>	125	°C/W
Thermal Resistance, Junction to Leads (Note 7)	R <sub>θJL</sub>	22	°C/W
Operating and Storage Temperature Range	T <sub>J</sub> , T <sub>STG</sub>	-55 to +150	°C

- Notes:
5. For a device surface mounted on FR-4 PCB with minimum suggested pad layout; high coverage of single sided 1 oz copper, in still air conditions
  6. Measured under pulsed conditions. Pulse width = 300μs. Duty cycle ≤ 2%.
  7. Thermal resistance from junction to solder-point (at the end of the collector lead).

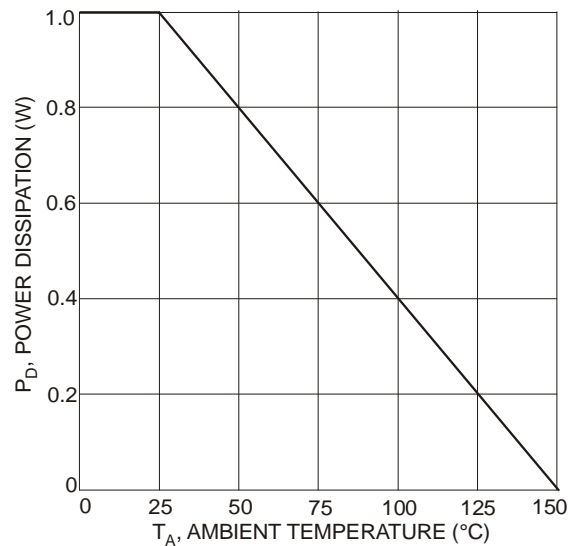


Figure 1. Power Dissipation vs. Ambient Temperature

**Electrical Characteristics** (@ $T_A = +25^\circ\text{C}$ , unless otherwise specified.)

Characteristic	Symbol	Min	Typ	Max	Unit	Test Condition
Collector-Base Breakdown Voltage	$BV_{CBO}$	40	-	-	V	$I_C = 100\mu\text{A}$
Collector-Emitter Breakdown Voltage (Note 8)	$BV_{CEO}$	32	-	-	V	$I_C = 10\text{mA}$
Emitter-Base Breakdown Voltage	$BV_{EBO}$	6	-	-	V	$I_E = 100\mu\text{A}$
Collector-Emitter Cut-off Current	$I_{CES}$	-	-	100	nA	$V_{CE} = 32\text{V}$
Collector-Base Cut-off Current	$I_{CBO}$	-	-	100	nA	$V_{CB} = 36\text{V}$
Base-Emitter Cut-off Current	$I_{EBO}$	-	-	100	nA	$V_{EB} = 6\text{V}$
Static Forward Current Transfer Ratio (Note 8)	$h_{FE}$	2DD1664P	82	180	-	$I_C = 100\text{mA}, V_{CE} = 3\text{V}$
		2DD1664Q	120	270		
		2DD1664R	180	390		
Collector-Emitter saturation Voltage (Note 8)	$V_{CE(sat)}$	-	120	400	mV	$I_C = 500\text{mA}, I_B = 50\text{mA}$
Transition frequency	$f_T$	-	280	-	MHz	$I_E = 50\text{mA}, V_{CE} = 5\text{V}, f = 30\text{MHz}$
Output Capacitance	$C_{ob}$	-	10	-	pF	$I_E = 0\text{A}, V_{CB} = 10\text{V}, f = 1\text{MHz}$

Notes: 8. Measured under pulsed conditions. Pulse width = 300 $\mu\text{s}$ . Duty cycle  $\leq 2\%$

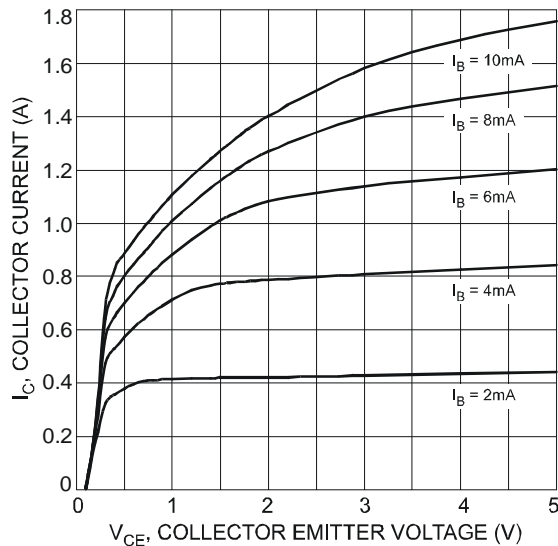
**Electrical Characteristics** (@ $T_A = +25^\circ\text{C}$ , unless otherwise specified.)


Figure 2. Typical Collector Current vs. Collector-Emitter Voltage

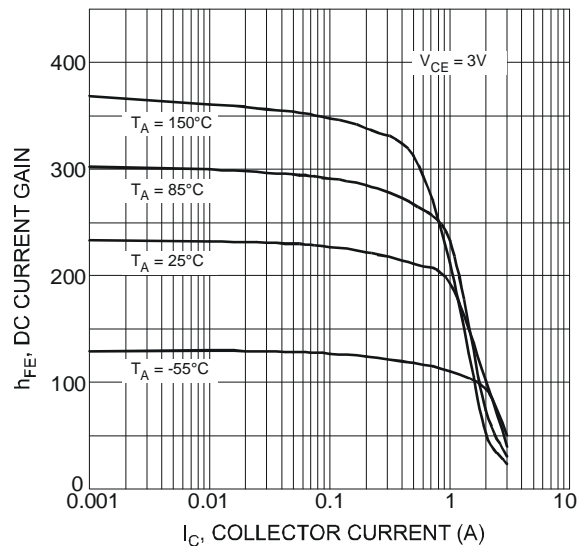


Figure 3. Typical DC Current Gain vs. Collector Current (2DD1664R)

**Electrical Characteristics** (cont.) (@ $T_A = +25^\circ\text{C}$ , unless otherwise specified.)

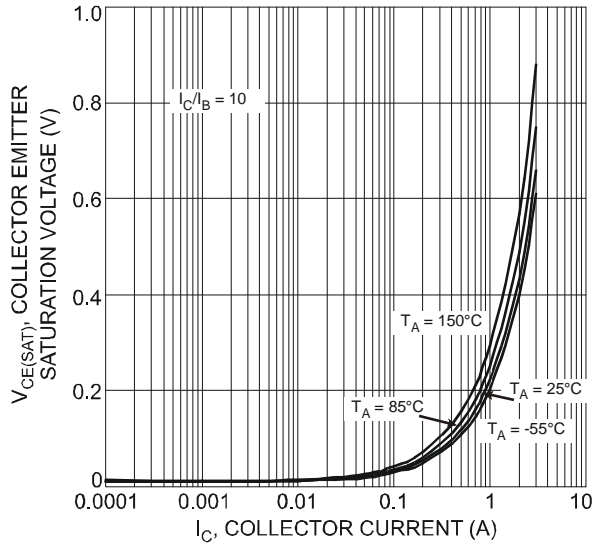


Figure 4. Typical Collector-Emitter Saturation Voltage vs. Collector Current

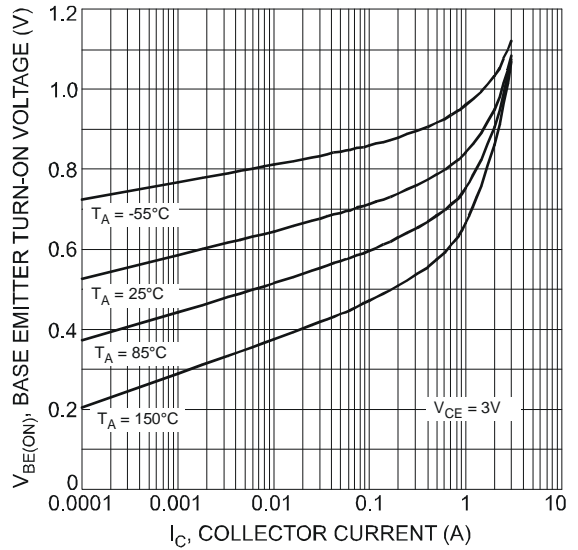


Figure 5. Typical Base-Emitter Turn-On Voltage vs. Collector Current

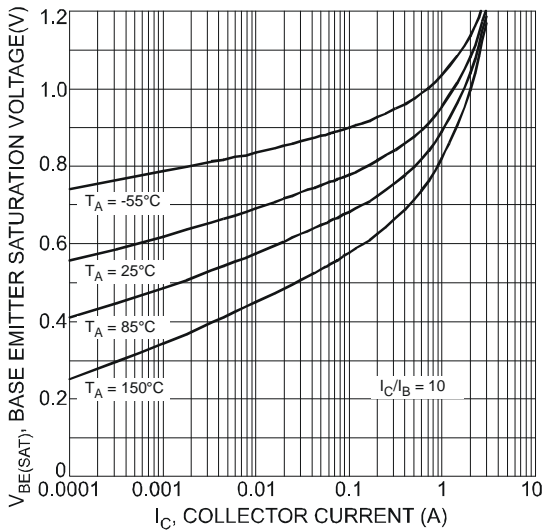


Figure 6. Typical Base-Emitter Saturation Voltage vs. Collector Current

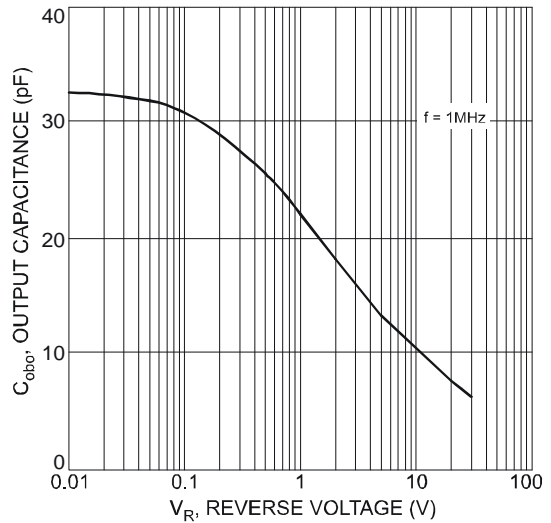


Figure 7. Typical Output Capacitance Characteristics

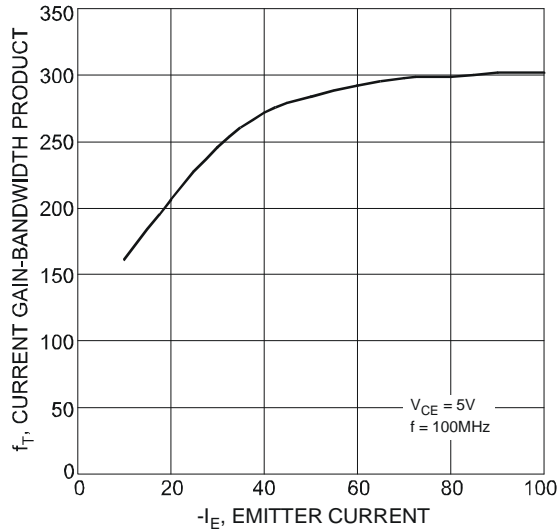
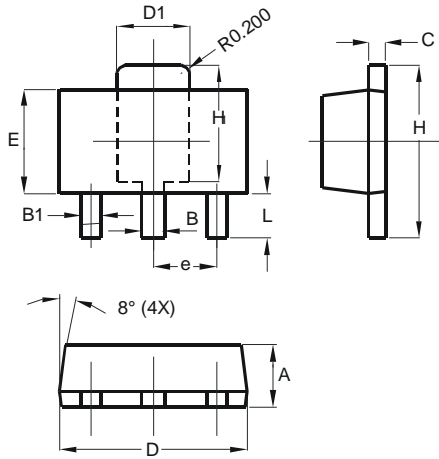


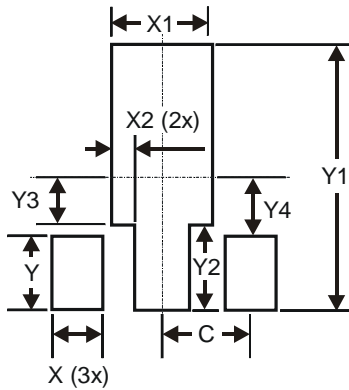
Figure 8. Typical Gain-Bandwidth Product vs. Emitter Current

**Package Outline Dimensions**



SOT89		
Dim	Min	Max
A	1.40	1.60
B	0.44	0.62
B1	0.35	0.54
C	0.35	0.44
D	4.40	4.60
D1	1.62	1.83
E	2.29	2.60
e	1.50 Typ	
H	3.94	4.25
H1	2.63	2.93
L	0.89	1.20
All Dimensions in mm		

**Suggested Pad Layout**



Dimensions	Value (in mm)
X	0.900
X1	1.733
X2	0.416
Y	1.300
Y1	4.600
Y2	1.475
Y3	0.950
Y4	1.125
C	1.500

**IMPORTANT NOTICE**

DIODES INCORPORATED MAKES NO WARRANTY OF ANY KIND, EXPRESS OR IMPLIED, WITH REGARDS TO THIS DOCUMENT, INCLUDING, BUT NOT LIMITED TO, THE IMPLIED WARRANTIES OF MERCHANTABILITY AND FITNESS FOR A PARTICULAR PURPOSE (AND THEIR EQUIVALENTS UNDER THE LAWS OF ANY JURISDICTION).

Diodes Incorporated and its subsidiaries reserve the right to make modifications, enhancements, improvements, corrections or other changes without further notice to this document and any product described herein. Diodes Incorporated does not assume any liability arising out of the application or use of this document or any product described herein; neither does Diodes Incorporated convey any license under its patent or trademark rights, nor the rights of others. Any Customer or user of this document or products described herein in such applications shall assume all risks of such use and will agree to hold Diodes Incorporated and all the companies whose products are represented on Diodes Incorporated website, harmless against all damages.

Diodes Incorporated does not warrant or accept any liability whatsoever in respect of any products purchased through unauthorized sales channel. Should Customers purchase or use Diodes Incorporated products for any unintended or unauthorized application, Customers shall indemnify and hold Diodes Incorporated and its representatives harmless against all claims, damages, expenses, and attorney fees arising out of, directly or indirectly, any claim of personal injury or death associated with such unintended or unauthorized application.

Products described herein may be covered by one or more United States, international or foreign patents pending. Product names and markings noted herein may also be covered by one or more United States, international or foreign trademarks.

**LIFE SUPPORT**

Diodes Incorporated products are specifically not authorized for use as critical components in life support devices or systems without the express written approval of the Chief Executive Officer of Diodes Incorporated. As used herein:

A. Life support devices or systems are devices or systems which:

1. are intended to implant into the body, or
2. support or sustain life and whose failure to perform when properly used in accordance with instructions for use provided in the labeling can be reasonably expected to result in significant injury to the user.

B. A critical component is any component in a life support device or system whose failure to perform can be reasonably expected to cause the failure of the life support device or to affect its safety or effectiveness.

Customers represent that they have all necessary expertise in the safety and regulatory ramifications of their life support devices or systems, and acknowledge and agree that they are solely responsible for all legal, regulatory and safety-related requirements concerning their products and any use of Diodes Incorporated products in such safety-critical, life support devices or systems, notwithstanding any devices- or systems-related information or support that may be provided by Diodes Incorporated. Further, Customers must fully indemnify Diodes Incorporated and its representatives against any damages arising out of the use of Diodes Incorporated products in such safety-critical, life support devices or systems.

Copyright © 2012, Diodes Incorporated

[www.diodes.com](http://www.diodes.com)